

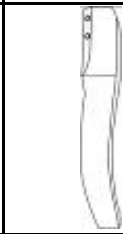





**ASSEMBLY INSTRUCTIONS FOR
JEWELRY ARMOIRE**

ITEM: EWB043	NO.	Description	Q'ty	Sketch	NO.	Description	Q'ty	Sketch
	1	Right Front Leg	1pc		5	Armoire	1pc	
	2	Left Front Leg	1pc		6	Top	1pc	
					7	Machine Screw	8pcs	
	3	Right Back Leg	1pc		8	Washer	8pcs	
					9	Screwdriver	1pc	
4	Left Back Leg	1pc		10	Small Wood Screw	4pcs		

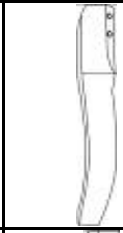
1. Attach the Right Front Leg (1) Left Front Leg (2), and the Right Back leg (3) Left Back Leg (4) to the bottom of the Armoire (5) With 8 Machine Screws (7) and 8 Washers (8) and by using Screwdriver(9).

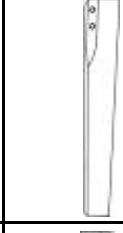

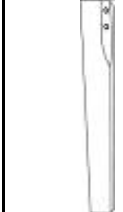
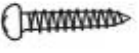
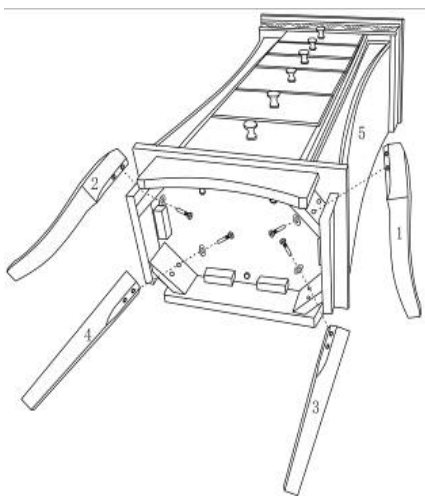
2. Carefully stand armoire upright on Legs , attached Top (6) to hinge at rear of the Armoire (5) with 5 Small Wood Screws (10) by using Screwdriver(9).

